

3M™ Pak 50 Low Profile Plug

.050" Plug, (1.27) Straight, Right Angle and SMT, Low Profile

P50LE Series



- Latch/eject mechanism maintains a secure connection
- Low profile 11.8 mm mated height when using the surfacemount version
- Mates to the P25LE wiremount socket
- RoHS Compliant. See the Regulatory Information Appendix (RIA) in the "RoHS Compliance" section of www.3Mconnector.com for compliance information (RIA E1 and C1 apply)

Date Modified: July 13, 2011

TS-1148-C
Sheet 1 of 4

Physical

Insulator:

Material: Glass Filled PPS

Flammability: UL 94V-0

Color: Brown

Contact Material: Phosphor Bronze

Plating:

Underplating: Nickel

Wiping Area: Gold Flash

Solder Tails: Gold Flash

Retaining Clips: Tin-Copper

Mating Compatibility: TS-1142

Electrical

Current Rating: 0.5 A

Insulation Resistance: $> 1 \times 10^9 \Omega$ at 250 V_{DC}

Withstanding Voltage: 300 V_{AC} for 1 minute

Environmental

Temperature Rating: -55°C to +85°C

Process Rating: 260°C MSL1 (per J-STD-020C)

UL File No.: E68080

3M
Electronic Solutions Division
Interconnect Solutions
<http://www.3Mconnector.com>

3M is a trademark of 3M Company.
For technical, sales or ordering information call
800-225-5373

3M™ Pak 50 Low Profile Plug

.050" Plug, (1.27) Straight, Right Angle and SMT, Low Profile

P50LE Series

Straight Plug (Through Hole Solder Tails)

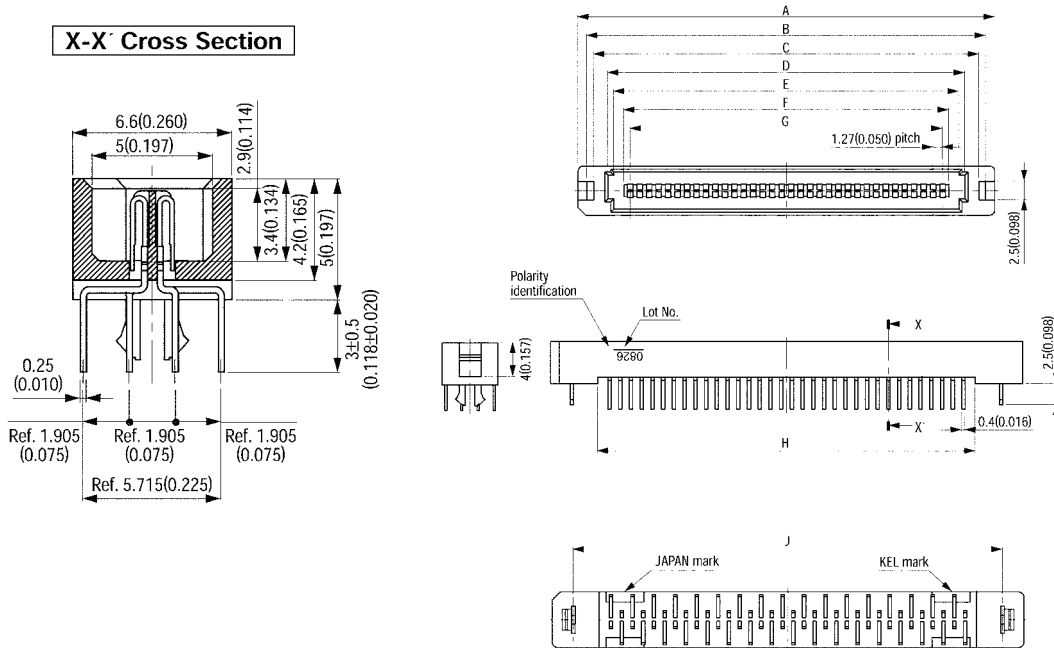

Printed Circuit Board Layout (Component Side View)

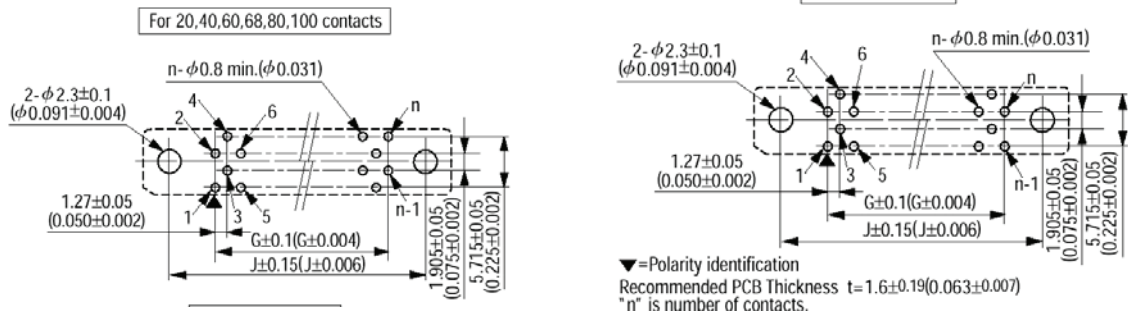

Ordering Information

P50LE - XXXP1 - XXX - DA (RIA E1 and C1 apply)

Contact Quantity: _____
See Table

Solder Tail Options:

- R1 = Straight/ .118" (3.0) Through hole
- RR1 = Right Angle/ .118" (3.0) Through hole
- SML = Vertical Surface Mounts

TS-1148-C
Sheet 2 of 4

3M™ Pak 50 Low Profile Plug

.050" Plug, (1.27) Straight, Right Angle and SMT, Low Profile

P50LE Series

Product Table / Dimensions for Straight and Right Angle Thru-hole Plug

Contact Quantity	A	B	C	D	E	F	G	H	J
20	25.43 [1.001]	23.03 [0.906]	21.23 [0.836]	17.43 [0.686]	15.83 [0.623]	13.13 [0.517]	11.43 [0.450]	14.23 [0.560]	20.32 [0.800]
30	31.78 [1.251]	29.38 [1.157]	27.58 [1.086]	23.78 [0.936]	22.18 [0.873]	19.48 [0.767]	17.78 [0.700]	20.58 [0.810]	26.67 [1.050]
40	38.13 [1.501]	35.73 [1.407]	33.93 [1.336]	30.13 [1.186]	28.53 [1.123]	25.83 [1.017]	24.13 [0.950]	26.93 [1.060]	33.02 [1.300]
50	44.48 [1.751]	42.08 [1.657]	40.28 [1.586]	36.48 [1.436]	34.88 [1.373]	32.18 [1.267]	30.48 [1.200]	33.28 [1.310]	39.37 [1.550]
60	50.83 [2.001]	48.43 [1.907]	46.63 [1.836]	42.83 [1.686]	41.23 [1.623]	38.53 [1.517]	36.83 [1.450]	39.63 [1.560]	45.72 [1.800]
68	55.91 [2.201]	53.51 [2.107]	51.71 [2.036]	47.91 [1.886]	46.31 [1.823]	43.61 [1.717]	41.91 [1.650]	44.71 [1.760]	50.80 [2.000]
80	63.53 [2.501]	61.13 [2.407]	59.33 [2.336]	55.53 [2.186]	53.93 [2.123]	51.23 [2.017]	49.53 [1.950]	52.33 [2.060]	58.42 [2.300]
100	76.23 [3.001]	73.83 [2.907]	72.03 [2.836]	68.23 [2.686]	66.63 [2.623]	63.93 [2.517]	62.23 [2.450]	65.03 [2.560]	71.12 [2.800]

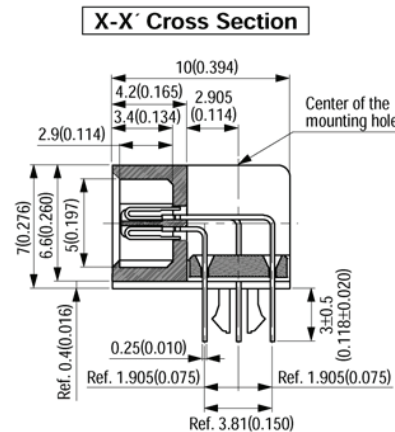

Right Angle Plug (Through Hole Solder Tails)

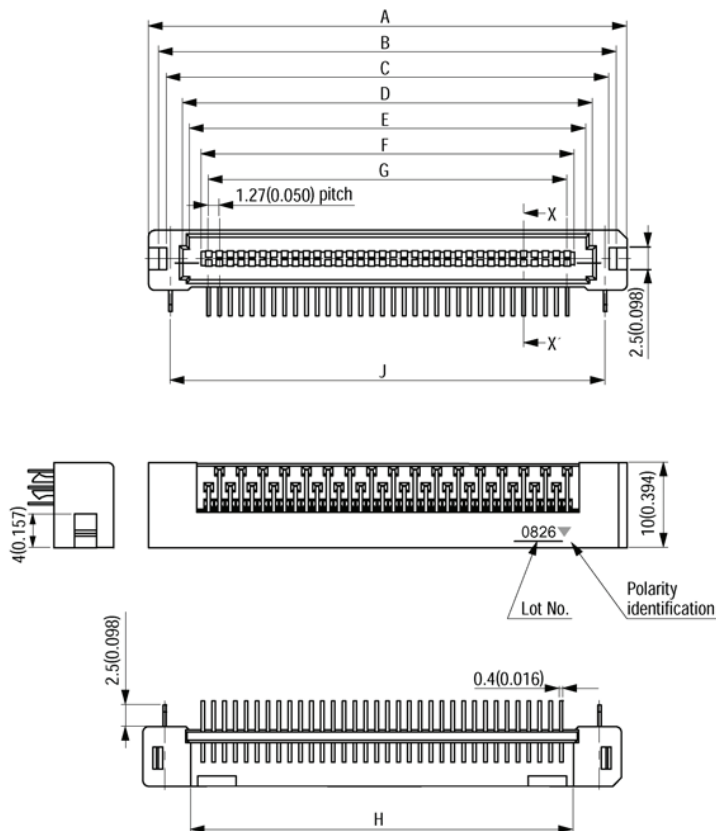

Printed Circuit Board Layout (Component Side View)

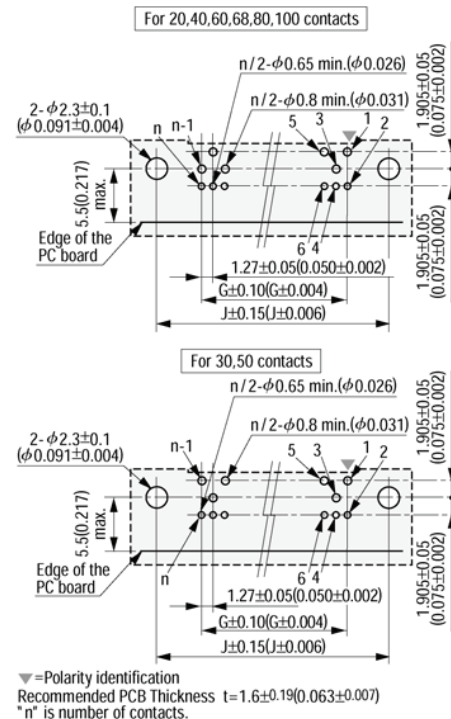

3M™ Pak 50 Low Profile Plug

.050" Plug, (1.27) Straight, Right Angle and SMT, Low Profile

P50LE Series

Product Table / Dimensions for SMT Plug

Contact Quantity	A	B	C	D	E	F	G	H	J
20	25.43 [1.001]	23.03 [0.907]	21.23 [0.836]	17.43 [0.686]	15.83 [0.623]	13.13 [0.517]	11.43 [0.450]	14.23 [0.560]	16.51 [0.650]
30	31.78 [1.251]	29.38 [1.157]	27.58 [1.086]	23.78 [0.936]	22.18 [0.873]	19.48 [0.767]	17.78 [0.700]	20.58 [0.810]	22.86 [0.900]
40	38.13 [1.501]	35.73 [1.407]	33.93 [1.336]	30.13 [1.186]	28.53 [1.123]	25.83 [1.017]	24.13 [0.950]	26.93 [1.060]	29.21 [1.150]
50	44.48 [1.751]	42.08 [1.657]	40.28 [1.586]	36.48 [1.436]	34.88 [1.373]	32.18 [1.267]	30.48 [1.200]	33.28 [1.310]	35.56 [1.400]
60	50.83 [2.001]	48.43 [1.907]	46.63 [1.836]	42.83 [1.686]	41.23 [1.623]	38.53 [1.517]	36.83 [1.450]	39.63 [1.560]	41.91 [1.650]
68	55.91 [2.201]	53.51 [2.107]	51.71 [2.036]	47.91 [1.886]	46.31 [1.823]	43.61 [1.717]	41.91 [1.650]	44.71 [1.760]	46.99 [1.850]
80	63.53 [2.501]	61.13 [2.407]	59.33 [2.336]	55.53 [2.186]	53.93 [2.123]	51.23 [2.017]	49.53 [1.950]	52.33 [2.060]	54.61 [2.150]
100	76.23 [3.001]	73.83 [2.907]	72.03 [2.836]	68.23 [2.686]	66.63 [2.623]	63.93 [2.517]	62.23 [2.450]	65.03 [2.560]	67.31 [2.650]

Straight Plug (SMT)

X-X' Cross Section

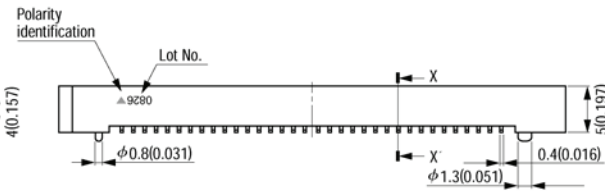
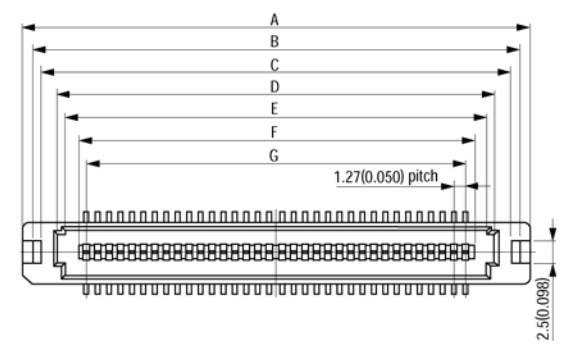
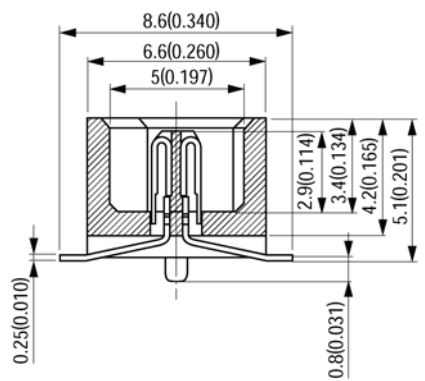

Printed Circuit Board Layout (Component Side View)

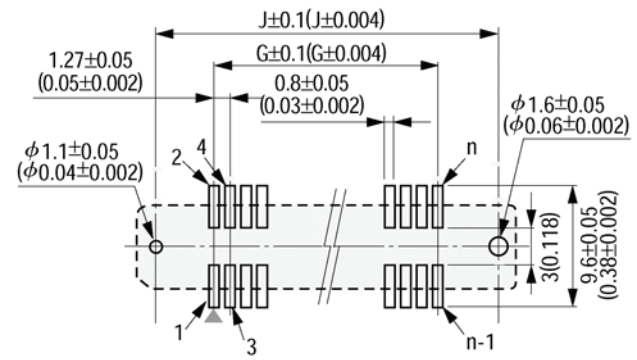

▼=Polarity identification
"n" is number of contacts.

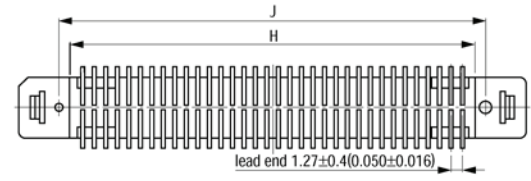

Important Notice

All statements, technical information, and recommendations related to 3M's products are based on information believed to be reliable, but the accuracy or completeness is not guaranteed. Before using this product, you must evaluate it and determine if it is suitable for your intended application. You assume all risks and liability associated with such use. Any statements related to the product which are not contained in 3M's current publications, or any contrary statements contained on your purchase order shall have no force or effect unless expressly agreed upon, in writing, by an authorized officer of 3M.

Warranty; Limited Remedy; Limited Liability.

This product will be free from defects in material and manufacture for a period of one (1) year from the time of purchase. **3M MAKES NO OTHER WARRANTIES INCLUDING, BUT NOT LIMITED TO, ANY IMPLIED WARRANTY OF MERCHANTABILITY OR FITNESS FOR A PARTICULAR PURPOSE.** If this product is defective within the warranty period stated above, your exclusive remedy shall be, at 3M's option, to replace or repair the 3M product or refund the purchase price of the 3M product. **Except where prohibited by law, 3M will not be liable for any indirect, special, incidental or consequential loss or damage arising from this 3M product, regardless of the legal theory asserted.**

**3M Electronics Solutions Division**

6801 River Place Blvd.
Austin, TX 78726-9000
U.S.A.
1-800-225-5373
www.3Mconnector.com

Please recycle. Printed in USA.
© 3M 2010. All rights reserved.
RIA-2217B-E

3M is a trademark of 3M Company.

Mouser Electronics

Authorized Distributor

Click to View Pricing, Inventory, Delivery & Lifecycle Information:

[3M:](#)

[P50LE-040P1-R1-DA](#) [P50LE-050P1-R1-DA](#) [P50LE-080P1-SML-DA](#) [P50LE-040P1-RR1-TGF](#) [P50LE-080P1-RR1-TGF](#) [P50LE-100P1-RR1-TGF](#) [P50LE-068P1-R1-TGF](#) [P50LE-100P1-R1-TGF](#) [P50LE-100P1-SML-TGF](#) [P50LE-068P1-RR1-TGF](#) [P50LE-020P1-SML-DA](#) [P50LE-030P1-R1-DA](#) [P50LE-030P1-SML-DA](#) [P50LE-068P1-R1-DA](#)