

# 48V SCM Series

## Series-Connected SuperCapacitor Modules



This new series of electrochemical, double-layer, series-connected SuperCapacitor modules offers excellent pulse power handling characteristics based on the combination of very high capacitance and very low ESR. Used by themselves or in conjunction with primary or secondary batteries, they provide extended back up time, longer battery life, and provide instantaneous power pulses as needed. Offers great solutions to Hold Up, Energy Harvesting, and Pulse Power Applications.

### FEATURES

- Low ESR provides high efficiency and high power density
- Withstands high vibrations and high current applications
- Life time capable of millions of cycles
- Active cell balancing

### APPLICATIONS

- Heavy industrial equipment
- Grid storage
- UPS/Industrial systems
- Regenerative energy capture
- Pitch control

### HOW TO ORDER

<b>SCM</b>	<b>Z</b>	<b>1E</b>	<b>P</b>	<b>167</b>	<b>S</b>	<b>R</b>	<b>B</b>	<b>B</b>	<b>0</b>
Series SuperCap Module	Width 190mm	Length 413mm	Voltage Code P = 48V	Capacitance Code 167 = 165F	Tolerance S = +30% / -10%	Lead Format R = Battery Post	Package B = Bulk	Balancing B = Active Balanced	Mounting 0 = Vertical

### QUALITY INSPECTION

Parts are tested for life cycle, high temperature load life, temperature characteristics, vibration resistance, and humidity characteristics. See page 2 for more information.

### TERMINATION

Power terminals are M8 (+) and M10 (-). Recommended torque is 20 Nm (M8) and 30 Nm (M10). See page 6 for more information on polarity.

### OPERATING TEMPERATURE

-40°C to +65°C @ 48V Balanced



For RoHS compliant products, please select correct termination style.

# 48V SCM Series

## Series-Connected SuperCapacitor Modules



### RATINGS & PART NUMBER REFERENCE

AVX Part Number	Length (mm)	Width (mm)	Height (mm)	Capacitance (F)	Capacitance Tolerance	Rated Voltage (V)	Rated Temperature (°C)	DCL Max @ 72 Hrs (uA)	ESR Max @ 1000 Hz (mΩ)	ESR Max @ DC (mΩ)	Peak Current (A)	Power Density (W/kg)	Max Energy (Wh)	Energy Density (Wh/kg)
<b>Battery Posts</b>														
SCMZ1EP167SRBB0	413	190	160	165	+30% / -10%	48	65		5.22		2165.8		52.14	

### QUALIFICATION TEST SUMMARY

Test	Test Method	Parameter	Limits
Life Cycle	Capacitors are cycled between rated voltage and half-rated voltage under constant current at +25°C for 500,000 cycles	Capacitance Change ESR Appearance	≤30% of initial spec value ≤2 times initial spec value No remarkable defects
High Temperature Load Life	Temperature: +65°C Voltage: Rated Voltage Test Duration: 2,000 hours	Capacitance Change ESR Appearance	≤30% of initial spec value ≤2 times initial spec value No remarkable defects
Storage Temperature Characteristics	Storage Duration: 2 years No Load Temperature: +35°C	Capacitance Change ESR Appearance	≤30% of initial spec value ≤2 times initial spec value No remarkable defects
Vibration Resistance	Amplitude: 1.5mm Frequency: 10 ~ 55Hz Direction: X, Y, Z for 2 hours each	Capacitance Change ESR Appearance	≤30% of initial spec value ≤2 times initial spec value No remarkable defects
Humidity	Voltage: Rated Voltage RH: 90% Temperature: +60°C Test Duration: 1,500 hours	Capacitance Change ESR Appearance	≤30% of initial spec value ≤2 times initial spec value No remarkable defects

### QUALITY AND RELIABILITY

#### Capacitance vs. Temperature

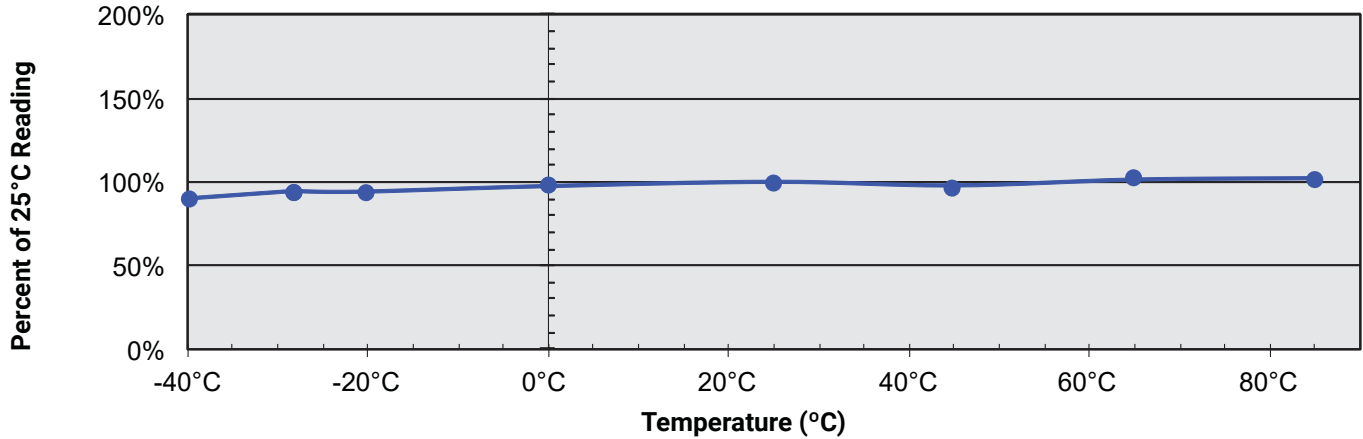

#### Leakage Current vs. Temperature

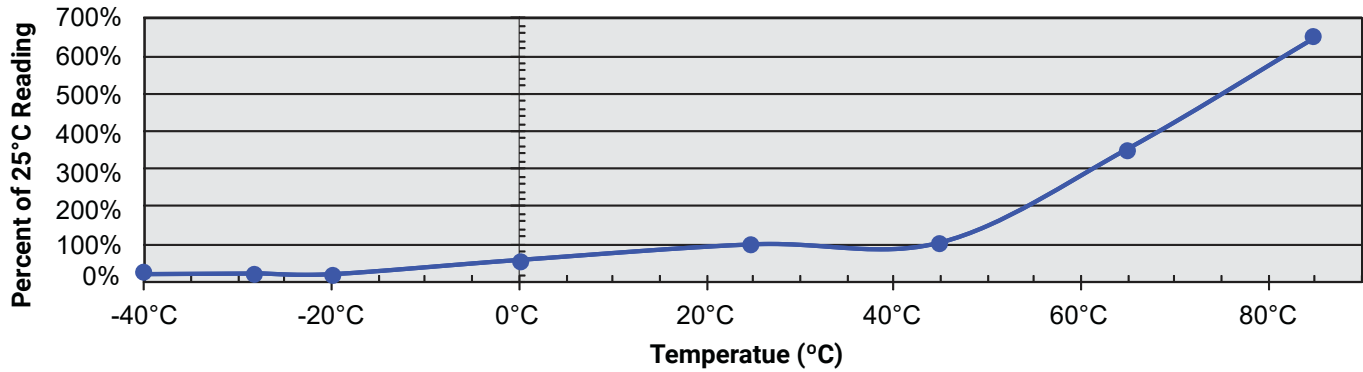

#### Equivalent Series Resistance vs. Temperature

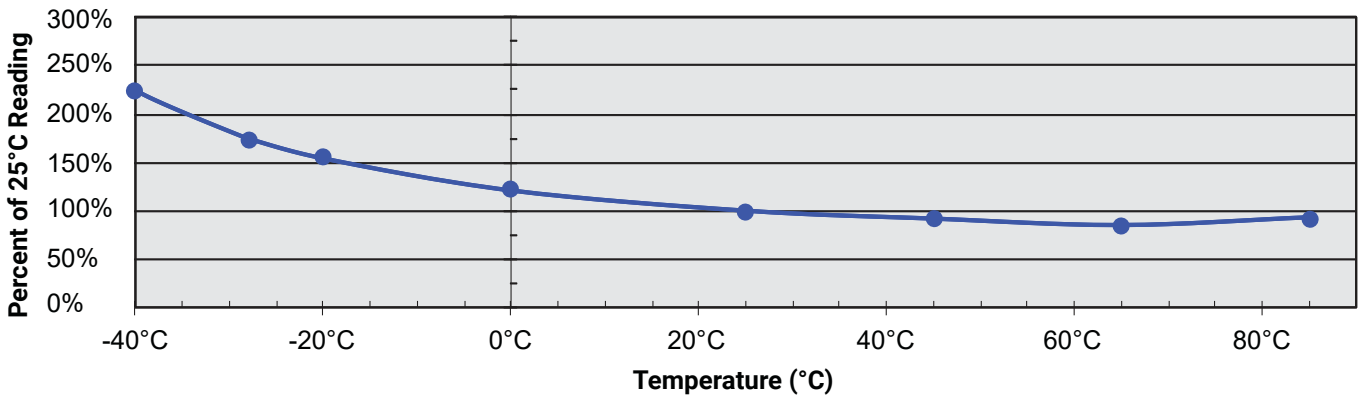

# 48V SCM Series

## Series-Connected SuperCapacitor Modules



### MECHANICAL SPECIFICATIONS

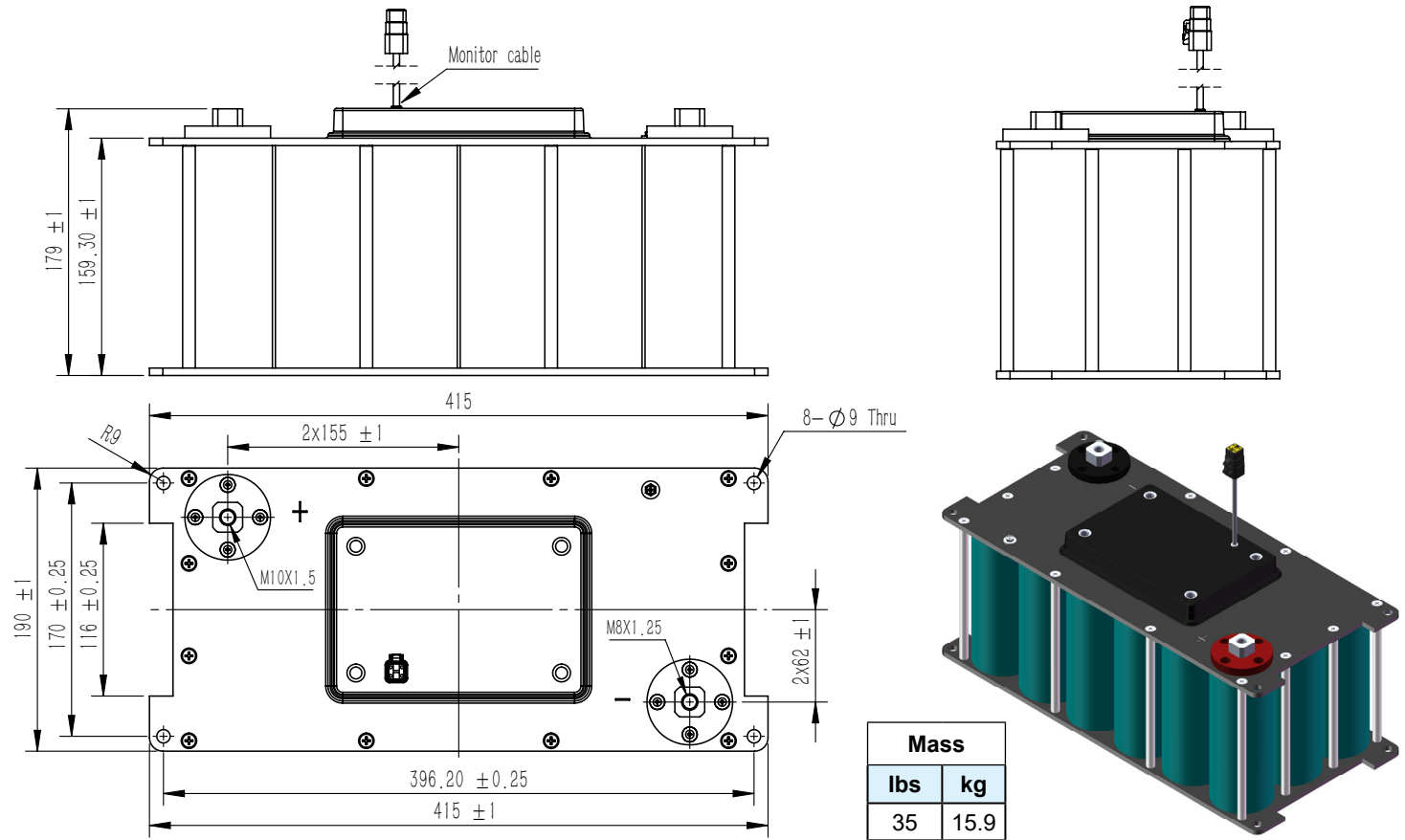

### Pin Out Designation

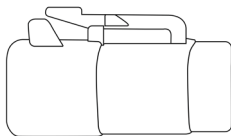

**Note:** Pin 2, the overvoltage signal, is an open collector transistor that pulls the pin low if any cell experiences an overvoltage condition. Pin 4, the temperature signal, has a 10K NTC device connected between it and the ground pin. The module temperature can be determined by reading the resistance of the NTC. See table below for resistance values at select intermediate temperatures.

Pin	Color	Designation
1	Black	Ground
2	White	Overvoltage
3	Red	Not used
4	Green	Temperature

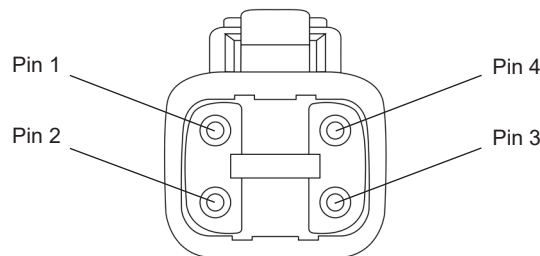

Temp (°C)	R <sub>T</sub> (Ω)
-40	332094
-25	129287
0	32554
25	10000
45	4372
65	2084
85	1070
100	677.3
125	338.7
150	182.6

### TEST METHODS

#### IEC Capacitance Test Method

- Capacitance is measured using a Keithley 2400 or 2602 Meter
- Procedure
  - Charge Capacitor to Rated Voltage at room temperature
  - Disconnect parts from voltage to remove charging effects
  - Discharge cells with a constant current I determined by  $4 * C * VR$
  - Noting V1, t1, V2, t2 and performing the calculation for C

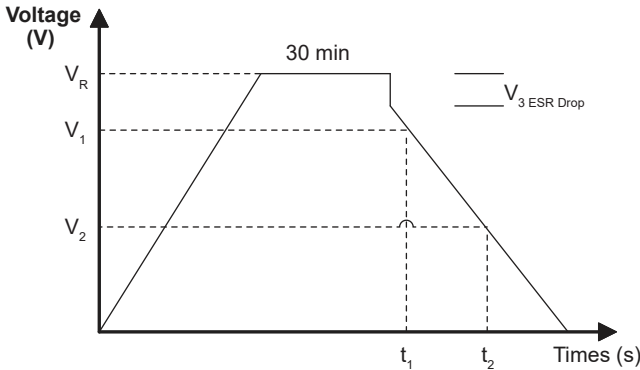

I – Discharge Current [mA],  $4 * C * VR$   
 VR – Rated Voltage  
 V1 – Initial Test Voltage, 80% of VR  
 V2 – Final Test Voltage, 40% of VR  
 t1 – Initial Test time  
 t2 – Final Test time  
 $C = I * (t2 - t1) / (V1 - V2)$

#### DCL Measurement @ 25°C

- DCL is measured using a Multimeter with high internal impedance across a resistor
  - Charge Capacitor to Rated Voltage at room temperature for 72 Hours
  - Disconnect parts from Voltage by opening switch 1 (Stabilize for 10 Min)
  - Measure Voltage across a known Valued Resistor (1K Ohm)
  - Calculate  $DCL = V/R$

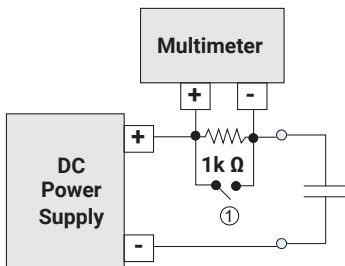

#### Initial ESR Measurement @ 25°C

- Using an Agilent 4263B LCR Meter and a Kelvin connection
- Measure at frequency of 1000 Hz
- Measurement Voltage of 10mV

#### DC ESR Measurement

- Six steps capacity and ESRDC Test Method is used as illustrated in the figure right.
  - Tests are carried out by charging and discharging the capacitor for two cycles at rated voltage and half rated voltage
  - $C = (CDC1 + CDC2) / 2$
  - $ESRDC = (ESRDC1 + ESRDC2) / 2$
- Where:  $CDC1 = I2 * (t5 - t4) / (V3 - V4)$   
 $CDC2 = I2 * (t11 - t10) / (V9 - V10)$   
 $ESRDC1 = (V5 - V4) / I2$   
 $ESRDC2 = (V11 - V10) / I2$   
 $I1 = I2 = 75mA/F$

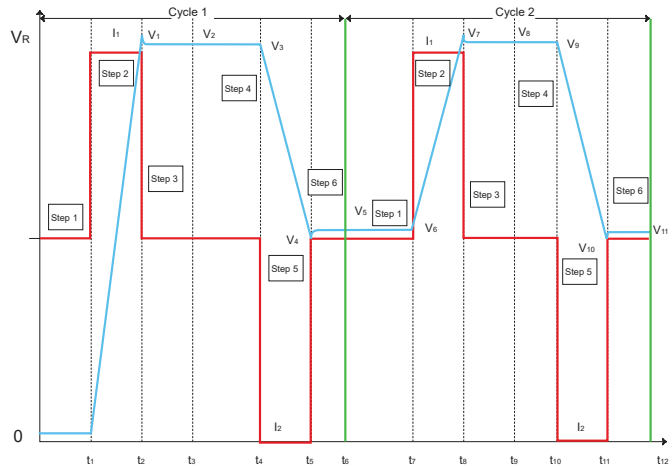

#### Maximum Operating Current

- This is the maximum current when capacitor temperature rise of the capacitor during its operation is less than 15°C

#### Maximum Peak Current

- This is the maximum current in less than 1 sec

#### Watt Density

- $Watt\ Density = (0.12 * V^2 / RDC) / mass$

#### Energy Density

- $Energy\ density = (1/2 * CV^2) / (3600 * mass)$

### POLARITY / REVERSE VOLTAGE

For product consistency and optimum performance, it is recommended that the capacitor be connected with polarity indicated. Reversing polarity will result in reduced module performance and permanent damage to the circuit.

### LIFE TIME AND TEMPERATURE PERFORMANCE

The life of a SuperCapacitor is impacted by a combination of operating voltage and the operating temperature according to the following equation:

$$\text{time to failure, } t \propto V^n \cdot \exp(-Q / k \cdot T) \dots\dots\dots(1)$$

where V is the voltage of operation, Q is the activation energy in electron volts (eV), k is the Boltzmann's constant in eV and T is the operating temperature in °K (where K is in degrees Kelvin). Typical values for the voltage exponent, n, is between 2.5 - 3.5, and Q is between 1.0 - 1.2 eV in the normal operating temperature range of 40° to 65°C.

The industry standard for SuperCapacitor end of life is when the equivalent series resistance, ESR, increases to 200% of the original value and the capacitance drops by 30%. Typically a supercapacitance shows an initial change in the ESR value and then levels off. If the capacitors are exposed to excessive temperatures the ESR will show a continuous degradation. In the extreme case, if the temperatures or voltages are substantially higher, than the rated voltage, this will lead to cell leakage or gas leakage and the product will show a faster change in the ESR which may increase to many times the original value.

Expected Lifetime at Various Voltages  
SCM Series 48V Rated for Balanced Modules

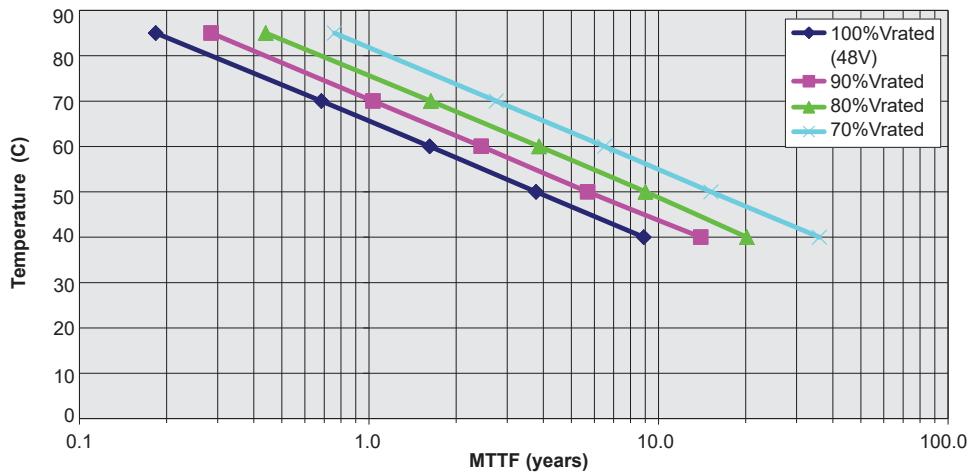

# 48V SCM Series

## Series-Connected SuperCapacitor Modules



### SAFETY RECOMMENDATIONS

#### Warnings

- To Avoid Short Circuit, after usage or test, Super Capacitor voltage needs to discharge to  $\leq 0.1V$
- Do not Apply Overvoltage, Reverse Charge, Burn or Heat Higher than  $150^{\circ}C$ , explosion-proof valve may break open
- Do not Press, Damage or disassemble the Super Capacitor, housing could heat to high temperature causing Burns
- If you observe Overheating or Burning Smell from the capacitor disconnect Power immediately, and do not touch

#### Emergency Applications

- If Housing is Leaking:
  - Skin Contact: Use soap and water thoroughly to wash the area of the skin
  - Eye Contact: Flush with flowing water or saline, and immediately seek medical treatment
  - Ingestion: Immediately wash with water and seek medical treatment

#### Transportation

Not subjected to US DOT or IATA regulations  
UN3499, <10Wh, Non-Hazardous Goods  
International shipping description –  
“Electronic Products – Capacitor”

Licensed by CAP-XX

#### Regulatory

- UL810a
- RoHS Compliant
- Reach Compliant / Halogen Free

#### Storage

- Capacitors may be stored within the operating temperature range of the capacitor
- Lower storage temperature is preferred as it extends the shelf life of the capacitor
- Do Not Store the Super Capacitors in the following Environments
  - High Temperature / High Humidity environments  $>40^{\circ}C / 70\% RH$
  - Direct Sunlight
  - In direct contact with water, salt oil or other chemicals
  - In direct contact with corrosive materials, acids, alkalis, or toxic gases
  - Dusty environment
  - In environment with shock and vibration conditions

# Mouser Electronics

Authorized Distributor

Click to View Pricing, Inventory, Delivery & Lifecycle Information:

[AVX:](#)

[SCMZ1EK507SRBB0](#) [SCMZ1EP167SRBB0](#)